

# An intercomparison study of optical particle size spectrometers for aerosol number size distribution measurements

Sébastien Bau<sup>1</sup>, Vincent Creenn<sup>2</sup>, Joris Leglise<sup>2</sup>, Sébastien Jacquinet<sup>3</sup>, Christophe Debert<sup>4</sup>, Denis Petitprez<sup>5</sup>, Valentine Bizet<sup>5</sup>, Lara Leclerc<sup>6</sup>, Alain Miffre<sup>7</sup>, Danael Cholleton<sup>7</sup>, Alec Rose<sup>8</sup>, Alexandre Tomas<sup>9</sup>, Amel Kort<sup>10</sup>, Didier Hebert<sup>11</sup>, Aurélie Joubert<sup>12</sup>, Florence Deschamps<sup>13</sup>, Sébastien Ritoux<sup>14</sup>, Lyes Ait Ali Yahia<sup>15</sup> and François Gaie-Levrel<sup>16#</sup>

<sup>1</sup>INRS, Laboratoire de Métrologie des Aérosols, 54500 Vandoeuvre les Nancy

<sup>2</sup>ADDAIR, 78530 Buc

<sup>3</sup>CEA, Laboratoire de Mesures, Sécurisation et Environnement, 38054 Grenoble Cedex 9

10 <sup>4</sup>Airparif, Laboratoire de métrologie et innovation, 75004 Paris

<sup>5</sup>Univ. Lille, CNRS, UMR8522 - PC2A – Physico-chimie des Processus de Combustion et de l'Atmosphère, 59000 Lille

<sup>6</sup>Mines Saint-Etienne, Univ Jean Monnet, INSERM, U1059 Sainbiose; Centre CIS, 42023 Saint-Etienne

<sup>7</sup>Institut Lumière Matière, UMR 5306 CNRS/U. Lyon, 69622 Villeurbanne cedex

<sup>8</sup>Service des Laboratoires de Santé Environnementale, Laboratoire Polluants Chimiques, 75013 Paris

15 <sup>9</sup>Institut Mines-Télécom, Université de Lille, Center for Energy and Environment, 59000 Lille

<sup>10</sup>ASNR, Laboratoire de Physique et de métrologie des aérosols, 91400 Saclay

<sup>11</sup>ASNR, Laboratoire Expérimental de Recherche et d'expertise sur les Transferts des radionucléides dans le milieu Atmosphérique, 50130 Cherbourg En Cotentin

<sup>12</sup>IMT Atlantique, GEPEA, CNRS UMR 6144, BP 20722, 44307 Nantes Cedex 3

20 <sup>13</sup>DGA Maîtrise NRBC, 91710 Vert-le-Petit

<sup>14</sup>CSTB, Direction Santé Confort, 77447 Marne-la-Vallée Cedex 2

<sup>15</sup>CERTES, Université Paris-Est Créteil, 94010 Créteil

<sup>16</sup>LNE, Direction de la Métrologie Scientifique et Industrielle, 75724 Paris Cedex 15

<sup>#</sup>Now at: Airparif, The air quality observatory for the Paris region, 7 rue Crillon, 75004 Paris

25 *Correspondence to:* Sébastien Bau (sebastien.bau@inrs.fr)

**Abstract.** An inter-laboratory comparison (ILC) involving optical particle size spectrometers (OPSSs) was organized at the French national level. The aim of this study was to make an inventory of the metrological capabilities of particle number size distribution (PNSD) measurements using OPSSs. This laboratory study was conducted over an 18-months period and involved 16 partners and 35 OPSSs. This large number of instruments provides strong statistical weight to the dataset, offering robust insight into the overall instrumental capabilities to accurately and reliably measure PNSD instead of establishing or developing a calibration procedure. For that, each partner applied the same pre-defined experimental protocol on the OPSS(s) to be tested, operated together with a common control OPSS. Three different test aerosols were involved, and their PNSDs were measured: (1) - a monodisperse amorphous silica sample, (2) - glass beads and (3) - a green cornstarch powder. This article presents the measured PNSD using the 35 OPSSs associated with the description of the experimental set-up, sample preparation protocol and comparison with Scanning Electron Microscopy measurements.

## 1 Introduction

Optical particle size spectrometers (OPSSs) are widely used to measure particle number size distributions. Their response is based on the light scattered by particles which occurs when a laser beam of defined wavelength interacts with focused particles. Each resulting detected scattered laser pulse corresponds to the occurrence of a particle, which allows temporal monitoring of the particle number concentration. The intensity of the scattered light at a given scattering angle is then analysed for each pulse to evaluate particle size. The latter is therefore expressed as an optical equivalent diameter ( $d_{opt}$ ) which corresponds to the diameter of a spherical particle that scatters the same light intensity as the one scattered by a particle of given refractive index, thus applying the Mie theory. As a result, after calibration by applying the Mie theory, OPSSs allow particle number size distribution (PNSD) measurements in real-time for particle sizes ranging from ~200 nm up to ~10  $\mu$ m. Their wide measurement range and fast response time make them well suited for ground-based measurements, as well as for aircraft measurements (Ortega et al., 2019). More recently, these instruments have also been increasingly used for workplace and indoor air quality monitoring (Maragkidou et al., 2018). However, these optical methods are dependent on particle size, shape, and refractive index. Accurate light scattering theories do not exist for complex particles for which the Mie theory appears as an approximation (Mishchenko et al., 2002). For this reason, downstream use of calibration factors is required, e.g. for converting number size distributions into mass concentrations.

Accurate particle size distributions require careful calibration of the OPSS detection efficiency against primary standards for particle number concentration. Size calibration is typically performed using spherical, non-absorbing polystyrene particles with well-defined diameter and refractive index (ISO 21501-1, 2009; ISO 21501-4, 2018). However, indoor, environmental and/or workplace aerosols consist of particles with varying shapes, sizes and complex refractive indices. Interestingly, very few OPSSs inter-laboratory comparisons (ILC) were performed over the last 50 years. In their work, (Hindman Li et al., 1978) performed a field comparison of PNSD measurements involving six OPSSs. Systematic differences between the measurements from the various instruments were smallest for sub-micron particles by a factor of 1.5-2.5 and largest for micron particles by a factor of 8-15. More than 40 years later, (Vasilatou et al., 2020) presented a first inter-laboratory comparison for low particle number concentrations dedicated to clean room facilities. Their study was conducted for particle size ranging from 300 nm up to 5  $\mu$ m and for number concentrations up to 2 particles. $\text{cm}^{-3}$  using polystyrene latex spheres and sodium chloride/lactose monohydrate aerosols. Such ILCs involved non-transportable facilities for the use of primary methods for measuring particle number concentrations in full requirements of the ISO 21501-4 standard (Horender et al., 2019; ISO 21501-4, 2018). For that reason, the authors used OPSSs as transfer standards that were shipped to all participants. They showed that all particle sizes agreed with the reference value within 7%, and were therefore compatible with the stated uncertainties. Meanwhile, (Iida and Sakurai, 2018) presented a new methodology for evaluating the OPSSs counting efficiencies based on an ink jet aerosol generator which allowed producing monodisperse particles at a constant rate with lactose monohydrate, ionic liquid, and sodium chloride. Nevertheless, and as stated by (Vasilatou et al., 2020), the metrological basis of this study remains incomplete

70 since the degree of equivalence was investigated by means of inter-laboratory comparisons. As a result, to the best of our knowledge, no ILC exists involving OPSSs for measuring PNSD, while such optical size spectrometers are used every day worldwide and precision is needed when precise air quality assessment is sought.

In this context, the present work aims to present the methodology and the results of an ILC involving a large number of OPSSs (35) for measuring PNSD by focusing on the same three test aerosols. This work does not consist of instrument calibration, but shall be considered as a possible metrological control, accounting for the statistical weight provided by the large ensemble of instruments implied. This ILC was conducted as a continuation of a previous study carried out on electrical mobility spectrometers (Gaie-Levrel et al., 2020) in which we stated that “new intercomparison studies on aerosol particle size distribution measurements will be organized by involving optical, aerodynamic and electrical mobility sizers using a common transportable control aerosol generator circulated among participants, following an approach similar to that proposed by (Gaie-Levrel et al., 2018) for particle mass concentration measurements”. We seized the opportunity of the French network, built through previous cooperations and conferences, to carry out this ILC at a national scale, thus involving 16 research groups. The overall objective of this study was to make an inventory of the metrological capabilities of various OPSS measurement techniques, with the idea to provide robust insight into their instrumental accuracy and to establish both a methodology and a reference dataset for improving their reliability. Since this work is not a calibration study, no reference devices (e.g. SMPS, APS, AAC-CPC) were used for validation, and no polystyrene standards were used. Indeed, experiments were carried out using three aerosol samples: (1) - a monodisperse amorphous silica sample, (2) - glass beads and (3) - a green cornstarch powder. There was no intention to generate test aerosols that would be representative of specific ones, e.g. a typical urban atmospheric aerosol. Instead, one of our objectives was to investigate the possibility to produce the same aerosols in the different laboratories involved by using an accessible generation setup using a dry-based method, as it seemed easier to provide the powders to all partners. To minimize biases, the dry-based aerosol generator involved in this work was identical for each partner and completed with a common running control OPSS.

## 2. Materials and methods

### 2.1 Experimental set-up

95 Inter-laboratory comparisons are usually constrained by the difficulty to move instruments at the same location in the same time. The strategy chosen in this study was to use of a unique laboratory experimental set-up, involving a common dry-aerosol generator and a control OPSS, which were sent to each participant prior to the experiments. Sixteen partners took part in this inter-comparison exercise and received every part in order to build the experimental set-up in their own laboratories, as presented in Figure 1.

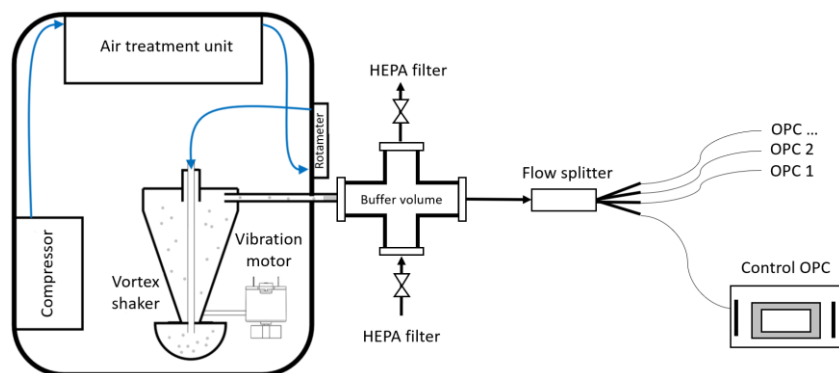

**Figure 1. Experimental set-up used by each partner for this study.**

105 The aerosol generator is based on the principle of a vortex shaker (VS-1000, ADDAIR, patent WO2013092816; (Leglise et al., 2022)). Within the generator, the filtered and dried air is injected from the upper part directly inside the Vortex mixer receptacle containing the powder sample to be aerosolised. The injection rod internal dimension is selected such as the flow in the receptacle is turbulent. The whole structure is connected to a vibrating motor with an eccentric mass to ensure stable and efficient agitation. The second zone, conical in shape, is subjected to an upward flow where the particles are selected according to their size by vertical elutriation. The air injection flow rate was set at 4 L/min for this study and the vibration frequency at 60 Hz (~12 V). A homogenization volume was coupled downstream of the generator in order to smooth temporal instabilities and to dilute the produced aerosols according to the total instrumental flowrate (Figure 1). A 4-way flow splitter (TSI model 3708) was involved to allow the use of multiple instruments in parallel, including the control OPSS. The latter was used as a common control measurement device (FIDAS Mobile, PALAS) in order to provide measurements with the same instrument in each laboratory in parallel with the OPSSs tested by each partner. Through the sixteen partners involved, 35 optical instruments were included in this inter-laboratory comparison, involving OPSSs with different technical specifications, as presented in Table 1. Since there was no intention of including exclusively freshly calibrated instruments, the latter were categorized according to the time delay between their last calibration and the date of the experiments. 40% of the instruments had been calibrated less than one year earlier to the experiments, 26% between 1 and 2 years, and 34% had been calibrated more than two years prior to the experiments. To limit this coincidence measurement artifacts and allow higher particle concentrations to be measured, a controlled sheath air flow can be included in the instrument design, as stated in Table 1.

110  
115  
120

125

**Table 1: OPSS types implicated in the present intercomparison study.**

	TSI	GRIMM				PALAS					
Model	OPS 3330	1.108	1.109	11D	Mini-Wras (optical part)	Fidas Mobile	Fidas Frog	Fidas 200	Promo/Welas		
Wavelength (nm)	660	780	655	655	660	Polychromatic					
Detection angle (°)	90 ± 60	90 ± 30				90 ± 5					
Number of channels (size range, µm)	16 (0.3–10)	15 (0.3–20)	31 (0.25–32)	31 (0.25–35)	31 (0.25–35)	64 (0.18–18)			128 (0.2–10 / 0.3–17)		
Flowrate (L/min)	1	1.2				1.4	4.8	5			
Sheath flow (L/min)	1	0.4				NA					
Maximum concentration (#/cm <sup>3</sup> )	3000	2000				5300				20 000	10 <sup>6</sup> (*): 2100 : 10 <sup>5</sup> , 2300 : 8000, 2500 : 800

(\*): Maximum concentration for 10 % coincidence error depending on measurement cell reference

130

## 2.2 Samples, preparation protocol and data acquisition

Three different test aerosols were investigated:

- 135 – (A) a monodisperse amorphous silica (Angströmsphere), 0.5 µm in size. This sample was used as a control sample, allowing to verify the instrumental accuracy and to adjust measurements when required. This silica sample was already studied in the past to determine its refractive index, *i.e.* 1.45 (Hubert et al., 2017). This sample is hereafter labelled as the *A-sample*.
- (B) glass beads, which are named as Spheriglass 5000CP00 (Potters) with refractive index in the range from 1.9 to 2.2. This sample is hereafter labelled as the *B-sample*.
- 140 – (C) a colored cornstarch powder, called green Holi powder (color people) with refractive index around 1.6. This sample is hereafter labelled as the *C-sample*.

145 While sample A consists of calibrated monodisperse particles in the low particle size range of OPSS, sample B consists of polydisperse spherical particle with optical properties close to those of calibration PSL particles. Sample C is the most complex test aerosol with polydisperse particles with non-spherical morphology. About 0.5 L of each powder (commercially available) were acquired, subsampled, provided to each participant and stored at room temperature and protected from light. Preparation protocols for powder samples to be analyzed were deliberately basic to be performed as simply as possible.

Figure 2 shows a typical scanning electron microscopy (SEM) image of airborne particles sampled on carbon TEM grid from each aerosol produced using the experimental setup presented in Figure 1 and using the Mini Particle Sampler (MPS) (R'Mili et al., 2013; Xiang et al., 2021) for these three samples.

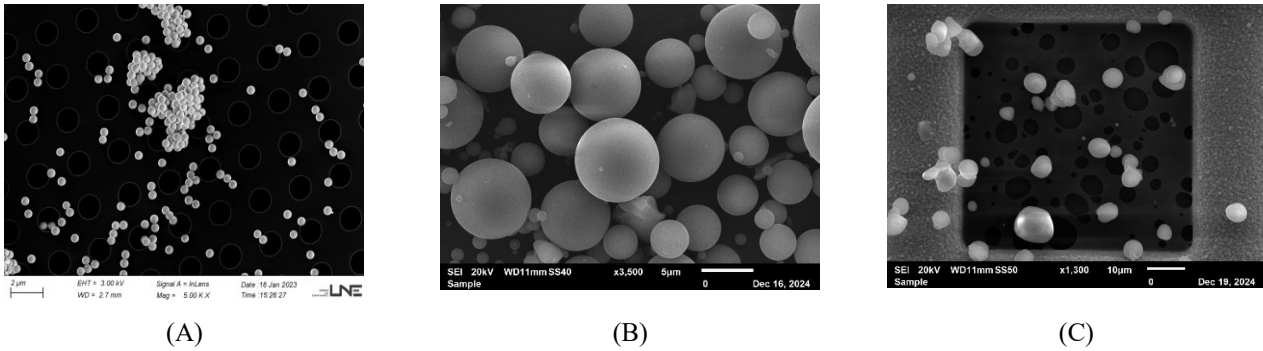

**Figure 2. SEM images for the three powder samples, *i.e.* (A) – monodisperse silica, (B) glass beads and (C) – Holi powder.**

From these SEM images, particle sizes were found to be  $0.486 \pm 0.015 \mu\text{m}$  for monodisperse amorphous silica,  $4.06 \pm 2.792 \mu\text{m}$  for Spheriglass, and  $4.117 \pm 0.899 \mu\text{m}$  for Holi powder. It is worth noting that SEM measurements correspond to the geometrical diameter of particles, which may be different from the equivalent optical diameter reported by OPSSs.  
 Regarding data acquisition, each partner was required to record PNSDs with a 10-second acquisition time per sample and a total duration of 10 minutes. A blank measurement was performed between samples. Each participant was responsible for the use of each OPSS under “good laboratory practices” conditions, in particular by ensuring the absence of internal errors reported by the devices, including coincidence errors.

### 160 3. Results and discussion

#### 3.1 Reference number size distributions

For each of the three test aerosols, all PNSDs measured by each partner with the control OPSS were used to calculate the averaged PNSD resulting from all measurements. Figure 3 presents the corresponding averaged PNSD for the three test aerosols. The presence of submicron particles for samples B and C, also visible in SEM pictures provided in Figure 2, could be linked to powder synthesis process or physical frictions between grains (attrition).  
 165

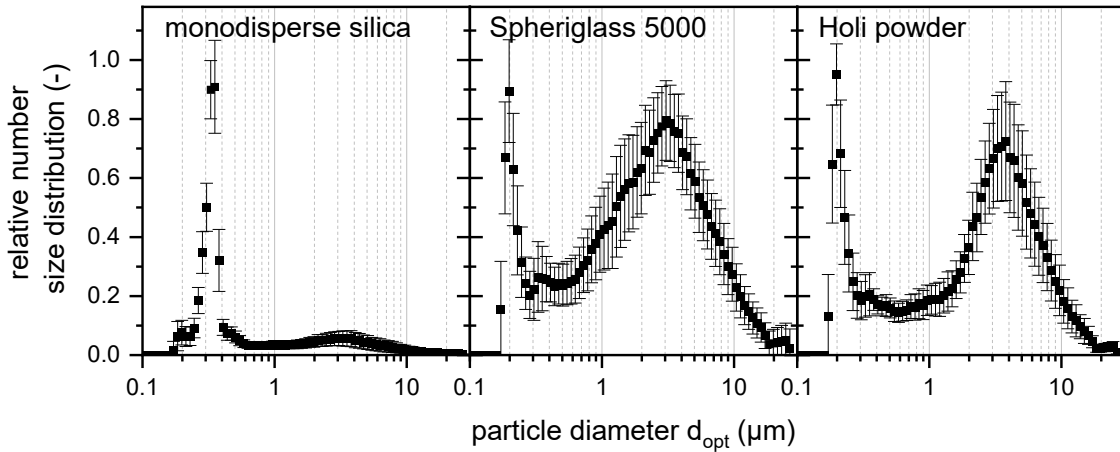

**Figure 3. Average relative particle number size distributions measured by the control Fidas mobile instrument for the three powder samples.** Errors bars corresponds to calculated standard deviations.

170

PNSDs were fitted with a lognormal law (OriginPro 2023), allowing the modal diameter and geometric standard deviation to be determined for each replicate; the characteristics of the PNSDs measured by the control OPSS are given in Table 2.

**Table 2: 90% confidence intervals of the measured PNSD from the control OPSS.**

	Modal optical diameter ( $\mu\text{m}$ )	Geometric standard deviation (-)
<i>A-sample</i>	0.32 – 0.34	1.09 – 1.12
<i>B-sample</i>	1.91 – 3.66	2.10 – 2.50
<i>C-sample</i>	3.02 – 4.32	1.65 – 1.97

175

It is important to note that default of accordance between SEM-based (Figure 2 and section 2.2) and OPSS-based modal diameter measurements can be due to the fact that SEM provide a geometric diameter whereas OPSSs return an equivalent optical diameter, *i.e.* the diameter of a particle with given refractive index that diffuses the same light intensity than the particle.

### 3.2 PNSD comparison and Z-Scoring

180

Since the total flow rate in the setup is dependent on the number and types of OPSSs involved by each partner, it was not possible to compare the total number concentrations. For that reason, data processing and interpretation are based on the relative number size distributions (*i.e.*  $dN/N_{\text{tot}} d \log d_{\text{opt}}$ ). In this study, modal diameters and geometric standard deviations (GSD) obtained from lognormal fits were considered, along with the corresponding determination coefficients ( $R^2$ ) characterizing the goodness of fit of the lognormal model for three different aerosols. Results are present in Figure 4 for silica,

185

Figure 5 for spheriglass and Figure 6 for Holi. In these figures, the grey area represents the 90% confidence interval on both the modal diameter and GSD given in Table 2, this providing a reference range for assessing inter-instrument agreement.

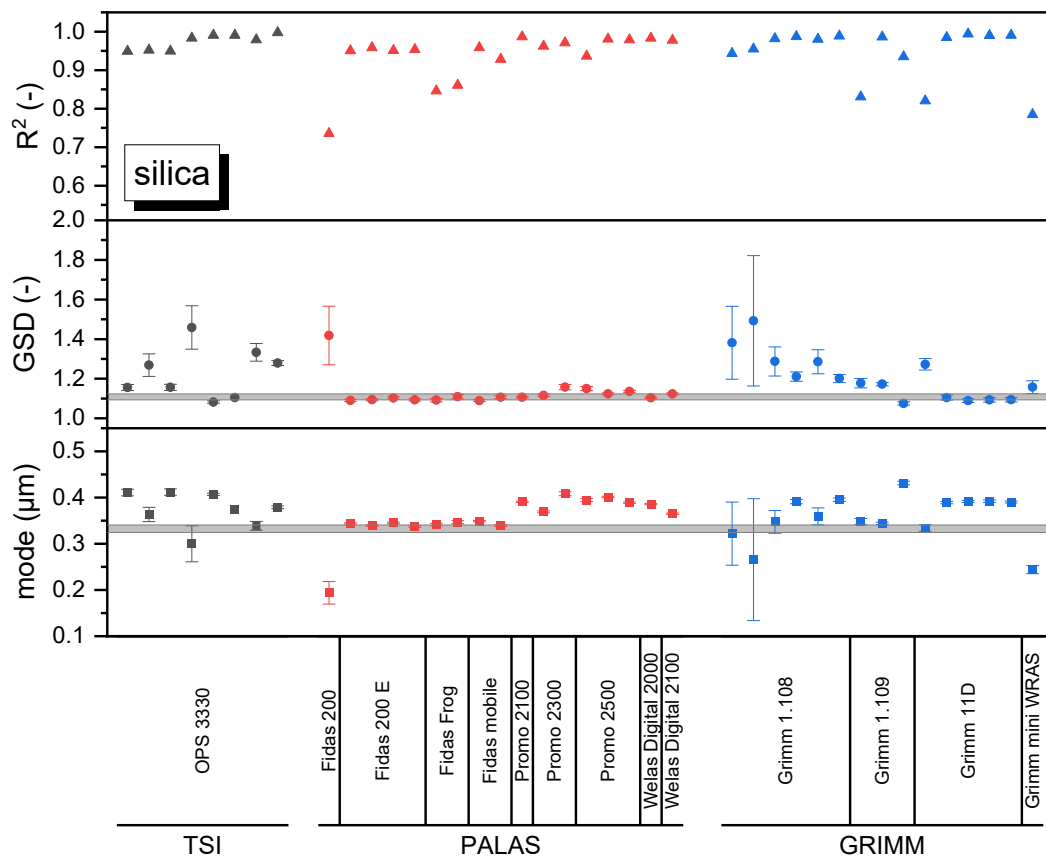

190 **Figure 4. PNSD parameters (mode, GSD) and lognormal model fit quality ( $R^2$ ) for monodisperse silica for the different instruments involved in the ILC. The grey area corresponds to the 90% confidence interval of the parameters obtained with the control instrument.**

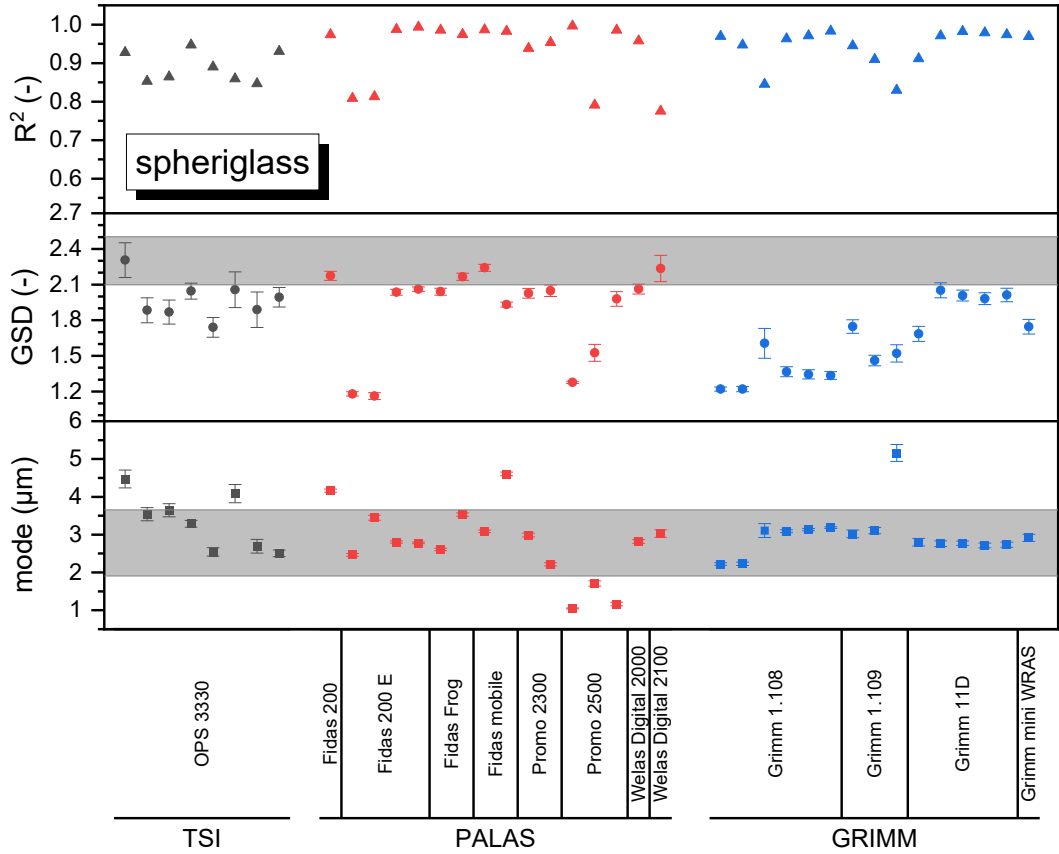

195

**Figure 5. PNSD parameters (mode, GSD) and lognormal model fit quality ( $R^2$ ) for spheriglass particles for the different instruments involved in the ILC. The grey area corresponds to the 90% confidence interval of the parameters obtained with the control instrument.**

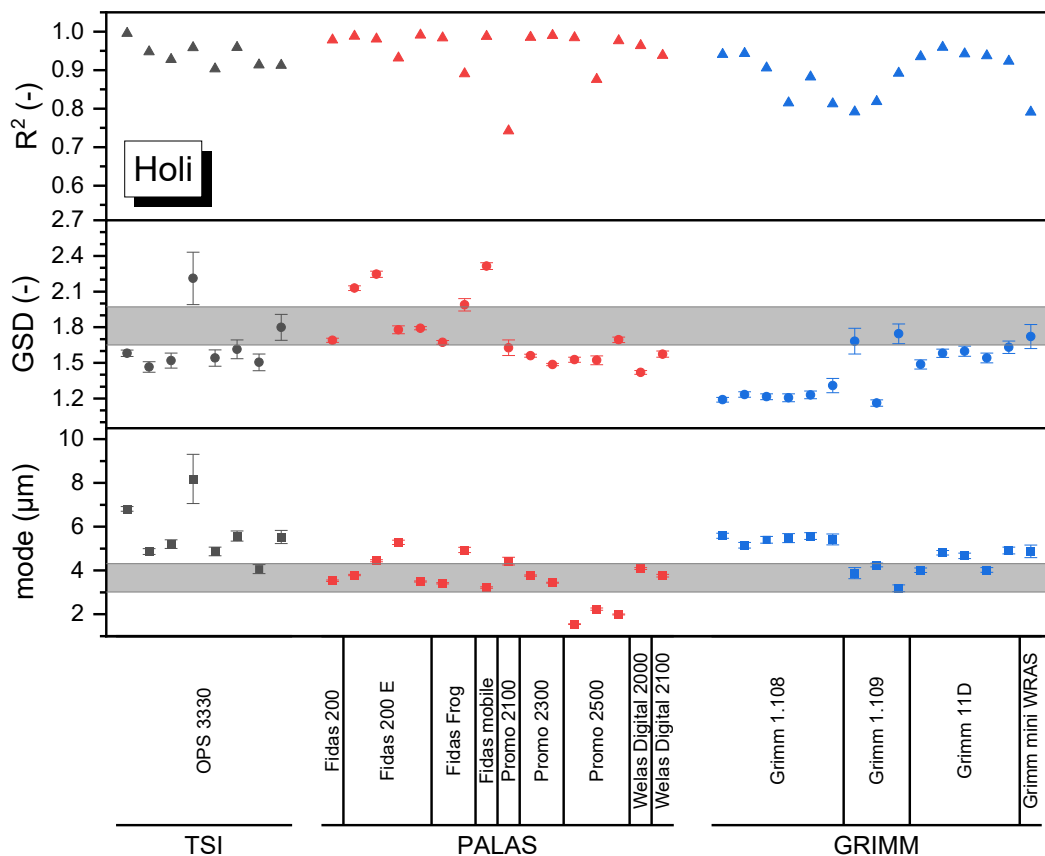

Figure 6. PNSD parameters (mode, GSD) and lognormal model fit quality ( $R^2$ ) for aerosolized Holi powder for the different instruments involved in the ILC. The grey area corresponds to the 90% confidence interval of the parameters obtained with the control instrument.

200

205 For monodisperse silica (Figure 4), the results show a high level of consistency between instruments for both the modal diameter and the GSD. Most measurements fall within or very close to the confidence interval defined by the control instrument. This limited dispersion reflects the well-controlled and stable nature of the monodisperse aerosol, which is inherently easier to characterize. The generally high  $R^2$  values further indicate that the lognormal model accurately represents the particle number size distribution for this type of aerosol.

210 For spheriglass (Figure 5), a larger variability is observed across instruments. Although several measurements remain within the confidence interval provided by the control OPSS, noticeable deviations appear, particularly for the GSD. The latter is most frequently lower for candidate instruments than for the control OPSS. Nonetheless, lower determination coefficients are also observed, suggesting that some GSD shall be considered with caution. This increased spread suggests a higher sensitivity to instrumental differences, possibly related to variations in measurement principles or particle/instrument interactions.

215 For Holi powder (Figure 6), the variability between instruments is even more pronounced. Significant differences are observed  
for both the modal diameter and the GSD with several measurements lying outside the confidence interval of the control  
instrument. This behavior is consistent with the complex and polydisperse nature of Holi powder aerosols as mentioned earlier,  
which are more challenging to characterize accurately. The diversity in particle size, shape, and composition likely contributes  
to discrepancies between instruments as different measurement techniques may respond differently to such heterogeneity. As  
220 a result, the quality of the lognormal fit ( $R^2$ ) is expected to be more variable, reflecting deviations from an ideal lognormal  
distribution.

Overall, the comparison across these results clearly highlights the influence of aerosol complexity on measurement  
reproducibility. While monodisperse silica yields highly consistent and reliable results across instruments, despite its low  
diameter range compared to the OPSS size detection limits, spheriglass particles introduce moderate variability, and Holi  
225 powder - due to its polydisperse and heterogeneous nature - leads to the largest discrepancies and uncertainty in the derived  
parameters.

Most measurements cluster near the control instrument, though a few outliers occur at both lower and higher values, likely  
reflecting differences in calibration, measurement methods or sample handling.

An analysis based on the Z-score performance criterion (ISO 13528, 2022; Thompson et al., 2006) was conducted in order to  
230 consider both the discrepancy between the modal diameters and the variability of the control measurement. Z is defined as:

$$Z = \frac{d_{mod_{OPSS_i}} - d_{mod_{OPSS^*}}}{2\sigma(d_{mod_{OPSS^*}})} \quad (1)$$

where  $d_{mod_{OPSS_i}}$  and  $d_{mod_{OPSS^*}}$  represent the modal diameters from the tested OPSS and from the control measurement  
235 respectively, and  $\sigma(d_{mod_{OPSS^*}})$  the repeatability standard deviation calculated from all the control measurements. Depending  
on the Z value, the measurements can then be classified into performance zones:

- $|Z| > 3$  are considered to be unsatisfactory values (“warning zone”);
- $2 < |Z| \leq 3$  are considered to be questionable values (“surveillance zone”);
- $1 < |Z| \leq 2$  are coherent values and correspond to acceptable performance;
- 240 -  $|Z| \leq 1$  are optimal values and correspond to excellent performance.

A similar analysis was conducted on the GSDs.

In order to better understand the Z-scoring, each OPSS involved in this interlaboratory comparison was classified in function  
of the technical specification associated to commercial type. The results are presented in Figure 7 for each aerosol sample. The  
245 results are shown separately for the mode diameter and the GSD. The Z-scores are grouped into the four categories represented

by different colors, while the contribution of each manufacturer (GRIMM, PALAS, and TSI) is indicated by distinct bar patterns.

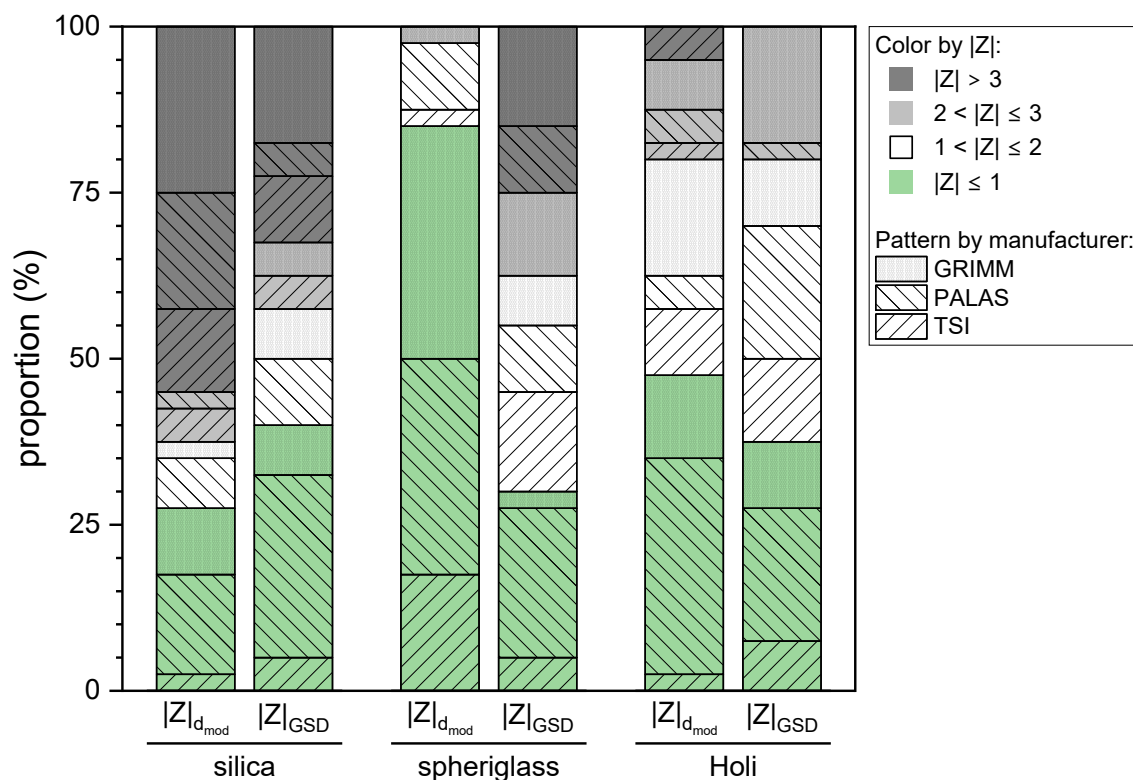

250

**Figure 7. Z-score calculated for each OPSS tested in the interlaboratory comparison for the three test aerosols (silica, spheriglass, Holi powder) in function of each manufacturer (TSI, PALAS, GRIMM).**

Overall, optimal or acceptable performances ( $|Z|_{d_{mod}} \leq 2$ ) are observed for 38% of instruments involved for silica, 97% for  
 255 spheriglass, and 80% for the Holi powder samples. Regarding the GSD ( $|Z|_{GSD} \leq 2$ ), these proportions are 58%, 63% and 80%,  
 respectively. These observations are interesting since the most complex sample, i.e. the Holi powder, does not yield the largest  
 Z-scores. This is due to a greater uncertainty stemming from the multiple measurements performed with the control OPSS  
 $\sigma(d_{mod_{OPSS^*}})$ , which lead to lower Z values. On the contrary, the highly repeatable PNSD obtained for monodisperse silica  
 results in larger Z-scores, with a large proportion (62% for the modal diameter, 42% for the GSD) in the questionable and  
 260 unsatisfactory ( $|Z| > 2$ ) categories linked to the size detection limit of each involved OPSS (180nm for PALAS and 250-300nm  
 for GRIMM & TSI, see Table 1). Because the number of specimens involved is not equivalent, the proportions of Z-scores are  
 specified by instrument manufacturer in Figure 8 for each test aerosols considered.

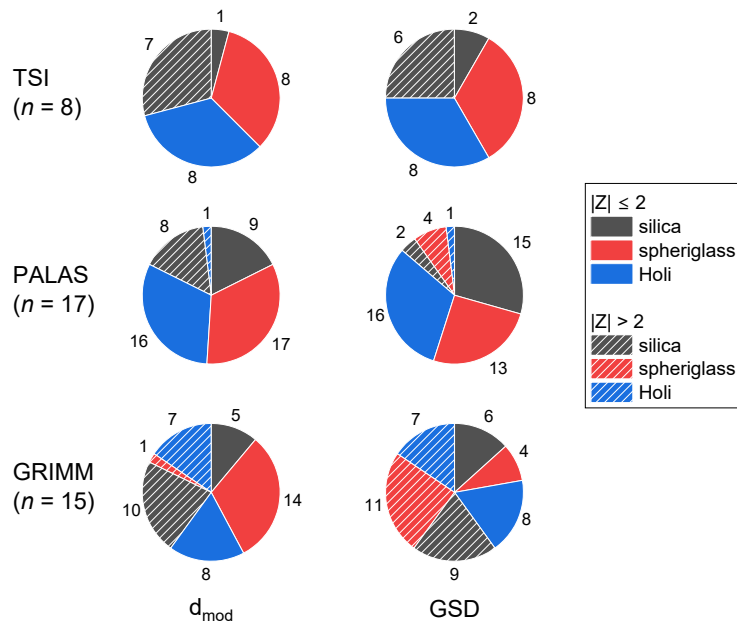

**Figure 8. Repartition of Z-scores ( $\leq 2$  and  $> 2$ ) for each OPSS manufacturer for the three test aerosols (silica, spheriglass, Holi powder) for both modal diameter and GSD.**

265

It can be seen from Figure 8 that  $\sim 71\%$  of TSI OPSSs involved in this ILC show optimal or acceptable performances ( $|Z|_{d_{mod}} \leq 2$ ). This percentage is even better for PALAS devices, with 82 to 86% in the same range of Z-scores for modal diameter and GSD, respectively. These proportions decrease to 60% and 40%, respectively, for the GRIMM instruments.

270 Overall, PALAS OPSSs achieve the best agreement with the control device, whereas GRIMM and, to a lesser extent TSI, show larger deviations.

These trends suggest that instrument design and measurement principles play a critical role in performance. Although this was not evident in the Z-scores analysis, the deviations with regards to the control OPSS are particularly important when dealing with heterogeneous and polydisperse particle populations.

275

It was then intended to seek dependence between Z-scores and instrumental characteristics. However, the correlation matrix did not reveal a significant effect of any parameter tested (number of size channels, time since last calibration, etc.). It is therefore believed that the biases between measured and control modal diameters are multi-factorial. One question rises about the choice of the mobile Fidas as a control instrument, which may have improved the performance evaluation of other PALAS devices. This choice was mainly motivated by the higher size-channel resolutions of PALAS OPSSs compared to the other types (Table 1). The size dependence and variability of the scattered light intensity with particle morphology and refractive index influence the performances of OPSSs (Szymanski et al., 2009). Other parameters can also impact the measured pulse height spectrum of OPSSs such as the coincidence due to the presence of more than one particle in the sensing volume and the

280

inability of the electronic system to process such events. These limitations may affect the comparability of results between  
285 different OPSS types which are usually calibrated by the manufacturers or, less frequently, by users. Calibration of OPSSs can  
also be used to characterize the instrument correlation to particles with different refractive index and morphology from those  
of calibration particles (Szymanski and Liu, 1986). In terms of particle size and number concentration, (Marple and Rubow,  
1976) calibrated an OPSS with respect to aerodynamic particle size using cascade impactors, which appears as a time-  
consuming methodology. Other approaches were also developed using cyclones and filters on the OPSS inlet. Comparisons to  
290 aerodynamic particle sizers, scanning mobility particle sizers and/or electron microscopy measurements were also performed  
(Binnig et al., 2007; Sousan et al., 2016). In that way, (Sang-Nourpour and Olfert, 2019) developed a new calibration technique  
involving an aerodynamic aerosol classifier (AAC) coupled to an OPSS to be tested for the size calibration and to a  
condensation particle counter for the number concentration. Their protocol presents the advantage of being not limited to a  
specific particle material or aerosol generation method. Among the parameters that may be at the origin of the deviations  
295 observed in relation to the control measurement, the degree of expertise of the operator in charge of the tests, as well as the  
time since the last calibration/maintenance of the device are to be considered. It is therefore difficult to pinpoint a single  
parameter responsible for the observed deviations between instruments and further propose a set of good laboratory practices.  
Depending on the aerosol concentration used during the experiments carried out by each partner, coincidence effects can have  
disproportionately affected measurements. Instrument-specific factors, including differences in size-channel resolution,  
300 calibration history, operator expertise and time since last maintenance, further complicate comparability and interpretation.  
Because OPSS devices are typically calibrated with reference particles whose optical properties do not match those of the test  
aerosols, these differences likely introduce significant biases in the particle size measurement, highlighting the challenges of  
achieving precise inter-laboratory agreement.

#### **4. Discussion and perspectives**

305 This inter-laboratory comparison provides a comprehensive assessment of the metrological performance of OPSSs for  
measuring particle number size distributions across a range of aerosols, without intention to generate specific test aerosols.  
This study provided an opportunity to bring together a large number of partners at the national level on a topic that still requires  
further scientific investigation, especially regarding the access to an affordable and widely deployable calibration bench for  
multiple laboratories. The standardization framework associated with OPSS calibration is highly complex, involving stringent  
310 requirements with specialized and non-portable facilities. In this context, the present study aimed to develop a common  
experimental setup that is straightforward to implement, easily transportable and highly versatile. Indeed, the system was  
designed to accommodate a wide range of test aerosols, enabling the generation of polydisperse aerosols in the micron size  
range, including solid and spherical aerosols. Such flexibility is particularly challenging to achieve with wet-generation  
systems, which are typically less adaptable and more constrained in terms of aerosol type and operating conditions.

315 The study involved 16 research groups and 35 OPSSs of various types, tested on three aerosol samples: monodisperse  
amorphous silica, glass beads, and green Holi powder. This originality lies in the fact that, despite using the same aerosol, the  
same generator, the same control measurement device, the same experimental protocol and the OPSS instruments from each  
participating laboratory, the reported results still differed in several cases. For the monodisperse silica sample, measurements  
were within  $\pm 30\%$  of the control OPSS, reflecting the high comparability of instruments for narrow size distributions.  
320 However, greater variability was observed for the glass beads and Holi powder, which exhibited broader size distributions and  
complex particle morphologies. When looking at the modal diameter provided by the different OPSSs, 72% of the instruments  
were in optimal or acceptable Z-score zones (71%, 82% and 60% for TSI, PALAS and GRIMM devices, respectively). Two  
thirds of the GSDs obtained by lognormal fit were found in the same range of Z-scores, 75% for TSI, 86% for PALAS and  
40% for GRIMM instruments.

325 Although most measurements clustered near the control, outliers highlighted systematic deviations linked to factors such as  
calibration history, size-channel resolution, particle morphology, and refractive index differences between calibration  
standards and test aerosols. Such properties are particularly difficult to determine, especially when complex particles are  
involved. Nonetheless, this study offers an essential starting point for future work that will need to address the more advanced  
calibration approaches and to further investigate how such methods could be implemented in practice. Coincidence effects due  
330 to higher aerosol concentrations during partner experiments were also identified as contributing to measurement variability,  
even if each participant was asked to make sure that each OPSS involved were used under “good laboratory practices”  
conditions, i.e. by ensuring the absence of internal errors reported by the devices, including coincidence errors.

These results confirm that while OPSSs provide generally reliable PNSD measurements, the observed inter-instrument  
deviations emphasize the complexity of ensuring consistent performance across laboratories. This study establishes both a  
335 methodology and a reference dataset for improving OPSS reliability at national and international scales. It underlines the need  
for strengthened robustness in aerosol measurements and for a clearer understanding of the sources of variability when  
instruments are deployed under routine monitoring conditions. Therefore, future work focusing on harmonizing calibration  
procedures using aerosols that better represent real-world optical properties, correcting for coincidence losses, and  
standardizing best practices for instrument maintenance and data acquisition is still needed. Expanding inter-laboratory  
340 comparisons to include a broader range of particle types, sizes, and concentrations will further strengthen confidence in OPSS  
measurements supporting more accurate and timely air quality monitoring.

### **Author contributions and competing interest**

SB and FGL conceived and designed this study from scientific, technical, and partnership perspectives. SB was primarily  
involved in data processing, while FGL focused on the dissemination and valorization of the results. All partners contributed  
345 to the work according to a defined timeline, including the provision and use of the generator, and the project was carried out  
without dedicated funding. The authors declare that there are no competing interests or conflicts of interest among the partners.

## References

- Arfin, T., Pillai, A. M., Mathew, N., Tirpude, A., Bang, R., and Mondal, P.: An overview of atmospheric aerosol and their effects on human health, *Environmental Science and Pollution Research*, 30, 125347–125369, <https://doi.org/10.1007/s11356-023-29652-w>, 2023.
- 350 Binnig, J., Meyer, J., and Kasper, G.: Calibration of an optical particle counter to provide PM<sub>2.5</sub> mass for well-defined particle materials, *J. Aerosol Sci.*, 38, 325–332, <https://doi.org/10.1016/j.jaerosci.2006.12.001>, 2007.
- CEN/TS 16450: Ambient air—Automated measuring systems for the measurement of the concentration of particulate matter (PM<sub>10</sub>; PM<sub>2.5</sub>), 2013.
- 355 European Parliament: Directive 2008/50/EC of the European Parliament and of the Council of 21 May 2008 on ambient air quality and cleaner air for Europe. Official J.L 152 1-44, 2008.
- Gaie-Levrel, F., Bourrous, S., and Macé, T.: Development of a portable reference aerosol generator (PRAG) for calibration of particle mass concentration measurements, *Particuology*, 37, 134–142, <https://doi.org/10.1016/j.partic.2017.06.005>, 2018.
- Gaie-Levrel, F., Bau, S., Bregonzio-Rozier, L., Payet, R., Artous, S., Jacquinet, S., Guiot, A., Ouf, F. X., Bourrous, S., Marpillat, A., Foulquier, C., Smith, G., Crenn, V., and Feltin, N.: An intercomparison exercise of good laboratory practices for nano-aerosol size measurements by mobility spectrometers, *Journal of Nanoparticle Research* 2020 22:5, 22, 103–, <https://doi.org/10.1007/s11051-020-04820-y>, 2020.
- 360 Gebhart, J.: Optical direct-reading techniques: Light intensity systems. In *Aerosol measurement: Principles, techniques, and applications*. New York: Wiley-Interscience., 419–454, 2001.
- 365 Görner, P., Simon, X., Bémer, D., and Lidén, G.: Workplace aerosol mass concentration measurement using optical particle counters, *Journal of Environmental Monitoring*, 14, 420–428, <https://doi.org/10.1039/c1em10558b>, 2012.
- Hindman Ii, E. E., Trusty, G. L., Hudson, J. G., Fitzgerald, J. W., and Rogersi, C. F.: *Atmospheric*, 1195–1200 pp., 1978.
- Horender, S., Auderset, K., and Vasilatou, K.: Facility for calibration of optical and condensation particle counters based on a turbulent aerosol mixing tube and a reference optical particle counter, *Review of Scientific Instruments*, 90, <https://doi.org/10.1063/1.5095853>, 2019.
- 370 Hubert, P., Herbin, H., Visez, N., Pujol, O., and Petitprez, D.: New approach for the determination of aerosol refractive indices – Part II: Experimental set-up and application to amorphous silica particles, *J. Quant. Spectrosc. Radiat. Transf.*, 200, 320–327, <https://doi.org/10.1016/j.jqsrt.2017.03.037>, 2017.
- Iida, K. and Sakurai, H.: Counting efficiency evaluation of optical particle counters in micrometer range by using an inkjet aerosol generator, *Aerosol Science and Technology*, 52, 1156–1166, <https://doi.org/10.1080/02786826.2018.1505032>, 2018.
- 375 ISO 13528: Statistical methods for use in proficiency testing by interlaboratory comparison, 2022.
- ISO 21501-4: Determination of Particle Size Distribution—Single Particle Light Interaction Methods— Part 4: Light Scattering Airborne Particle Counter for Clean Spaces, 2018.

- Leglise, J., Crenn, V., Le Dur, D., and Gensdarmes, F.: Vers un passage au TRL 8 d'un disperseur de poudre de type vortex shaker, <https://doi.org/10.25576/ASFERA-CFA2022-28366>, 2022.
- Maragkidou, A., Jaghbeir, O., Hämeri, K., and Hussein, T.: Aerosol particles (0.3–10 µm) inside an educational workshop—Emission rate and inhaled deposited dose, *Build. Environ.*, 140, 80–89, <https://doi.org/10.1016/j.buildenv.2018.05.031>, 2018.
- Marple, V. A. and Rubow, K. L.: AERODYNAMIC PARTICLE SIZE CALIBRATION OF OPTICAL PARTICLE COUNTERS\*, *J. Aerosol Sci.*, Pergamon Press, 425–433 pp., 1976.
- Mishchenko, M. I., Travis, L. D., and Lacis, A. A.: *Scattering, Absorption, and Emission of Light by Small Particles*, 2002.
- NF EN 12341: Air ambiant - Méthode normalisée de mesurage gravimétrique pour la détermination de la concentration massique MP10 ou MP2,5 de matière particulaire en suspension, 2023.
- Ortega, J., Snider, J. R., Smith, J. N., and Reeves, J. M.: Comparison of aerosol measurement systems during the 2016 airborne ARISTO campaign, *Aerosol Science and Technology*, 53, 871–885, <https://doi.org/10.1080/02786826.2019.1610554>, 2019.
- Pfeifer, S., Müller, T., Weinhold, K., Zikova, N., Dos Santos, S. M., Marinoni, A., Bischof, O. F., Kykal, C., Ries, L., Meinhardt, F., Aalto, P., Mihalopoulos, N., and Wiedensohler, A.: Intercomparison of 15 aerodynamic particle size spectrometers (APS 3321): Uncertainties in particle sizing and number size distribution, *Atmos. Meas. Tech.*, 9, 1545–1551, <https://doi.org/10.5194/amt-9-1545-2016>, 2016.
- R'Mili, B., Le Bihan, O. L. C., Dutouquet, C., Aguerre-Charriol, O., and Frejafon, E.: Particle sampling by TEM grid filtration, *Aerosol Science and Technology*, 47, 767–775, <https://doi.org/10.1080/02786826.2013.789478>, 2013.
- Sang-Nourpour, N. and Olfert, J. S.: Calibration of optical particle counters with an aerodynamic aerosol classifier, *J. Aerosol Sci.*, 138, <https://doi.org/10.1016/j.jaerosci.2019.105452>, 2019.
- Sousan, S., Koehler, K., Hallett, L., and Peters, T. M.: Evaluation of the Alphasense optical particle counter (OPC-N2) and the Grimm portable aerosol spectrometer (PAS-1.108), *Aerosol Science and Technology*, 50, 1352–1365, <https://doi.org/10.1080/02786826.2016.1232859>, 2016.
- Szymanski, W. W. and Liu, B. Y. H.: *On the Sizing Accuracy of Laser Optical Particle Counters*, 1986.
- Szymanski, W. W., Nagy, A., and Czitrovsky, A.: Optical particle spectrometry-Problems and prospects, <https://doi.org/10.1016/j.jqsrt.2009.02.024>, July 2009.
- Thompson, M., Ellison, S. L. R., and Wood, R.: The International Harmonized Protocol for the proficiency testing of analytical chemistry laboratories: (IUPAC technical report), *Pure and Applied Chemistry*, 78, 145–196, <https://doi.org/10.1351/pac200678010145>, 2006.
- Vasilatou, K., Dirscherl, K., Iida, K., Sakurai, H., Horender, S., and Auderset, K.: Calibration of optical particle counters: First comprehensive inter-comparison for particle sizes up to 5 µm and number concentrations up to 2 cm<sup>-3</sup>, *Metrologia*, 57, <https://doi.org/10.1088/1681-7575/ab5c84>, 2020.

Xiang, M., Morgeneuer, M., Aguerre-Chariol, O., Philippe, F., and Bressot, C.: Airborne nanoparticle collection efficiency of a TEM grid-equipped sampling system, *Aerosol Science and Technology*, 55, 526–538, <https://doi.org/10.1080/02786826.2020.1870923>, 2021.

415